

# BASE CABINET

## 1 Door, 1 Drawer (PA)

### ASSEMBLY INSTRUCTIONS

CODE	ITEM	QTY
A	Right   Left Side Panel	2
C	Drawer Right   Left Side Panel	2
D	Bottom Panel	1
E	Drawer Back Panel	1
F	Drawer Bottom Panel	1
G	Shelf	1
H	Back Panel	1
J	Toe Kick Plate	1
K	Drawer Glide-Cabinet	2
L	Drawer Glide-Drawer	2
M	Front Face	1
N	Drawer Front Panel	1
T	Rear Slide Bracket	2
U	Plastic Shelf Clips	4

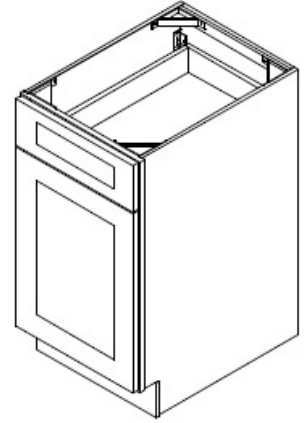

#### EASY ASSEMBLY METAL CLIP SYSTEM



- Align Clips ① and ②
- Slide ① into ②

- Insert locking screw into clip pair
- Tighten all screws

#### STEP 1

- Lay H flat; grooves facing upward
- Insert A into metal clips of H (refer to Metal Clip System)

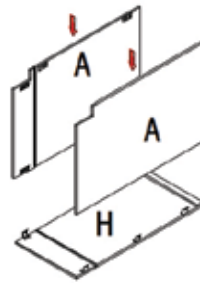

#### STEP 2

- Slide D into grooves of A and H

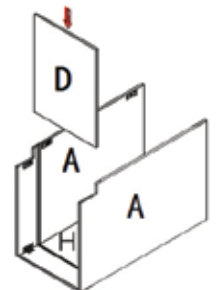

#### STEP 3

- Attach M onto D and A (refer to Metal Clip System)
- Attach J onto bottom front of A using the Metal Clip System

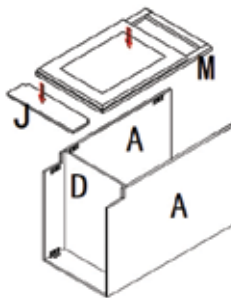

#### STEP 4

- Align C Right | Left with E so that the grooves line up and screw together
- Slide F into grooves of C and E
- Align N into C and F and tighten with screw

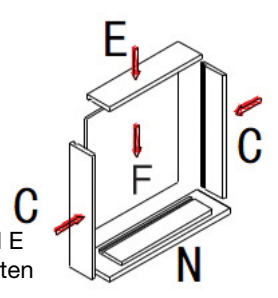

#### STEP 5

- Separate K and L of the drawer slide by extending slide and push down on black pin
- Attach drawer slide L to the pre-drilled holes on the two sides of C

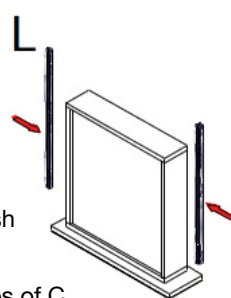

#### STEP 6

- Screw both rear brackets T into the pre-drilled holes in H so that angle faces upward
- Install K by sliding into T and screwing into side of M

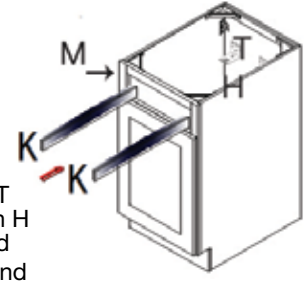

# BASE CABINET

## 1 Door, 1 Drawer (PA)

### ASSEMBLY INSTRUCTIONS

CODE	ITEM	QTY
A	Right   Left Side Panel	2
C	Drawer Right   Left Side Panel	2
D	Bottom Panel	1
E	Drawer Back Panel	1
F	Drawer Bottom Panel	1
G	Shelf	1
H	Back Panel	1
J	Toe Kick Plate	1
K	Drawer Glide-Cabinet	2
L	Drawer Glide-Drawer	2
M	Front Face	1
N	Drawer Front Panel	1
T	Rear Slide Bracket	2
U	Plastic Shelf Clips	4

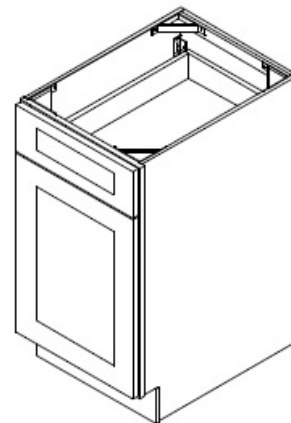

**EASY ASSEMBLY**  
METAL CLIP SYSTEM



- Align Clips ① and ②
- Slide ① into ②



- Insert locking screw into clip pair
- Tighten all screws

**STEP 7**

➤ Slide drawer box into cabinet so that L slides into K

**STEP 8**

➤ Insert shelf clips U into the pre-drilled holes on M  
➤ Slide shelf G making sure the front edge faces out