

# 2 DOOR PANTRY CABINET

## ASSEMBLY INSTRUCTIONS

CODE	ITEM	QTY
A	Right   Left Side Panel	2
D	Bottom Panel	3
G	Shelf	4*
J	Toe Kick Panel	1
H	Back Panel	1
M	Front Face	1

\*96" pantry cabinets come with 5 shelves

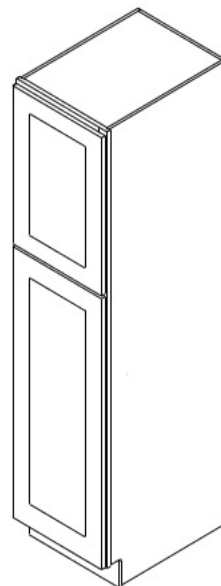

**EASY ASSEMBLY METAL CLIP SYSTEM**



- Align Clips ① and ②
- Slide ① into ②
- Insert locking screw into clip pair
- Tighten all screws

**STEP 1**

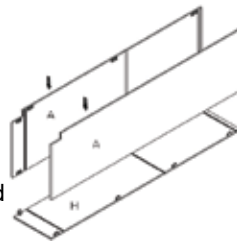

- Lay H flat; grooves facing upward
- Insert A into metal clips of H (refer to Metal Clip System)

**STEP 2**

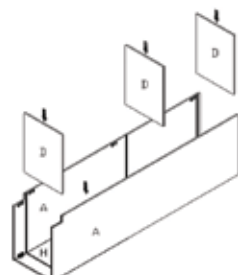

- Slide D into grooves of A and H

**STEP 3**

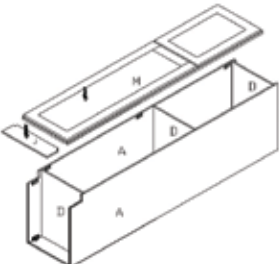

- Attach M onto D and A (refer to Metal Clip System)
- Attach J onto bottom of A using the Metal Clip System

**STEP 4**

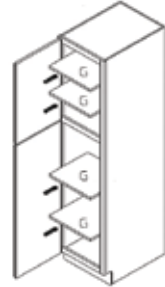

- Stand cabinet upright
- Install G by placing shelf clips into pre-drilled holes